



**FLAGS &
FLAGPOLES**



**LARGE
FORMAT
PRINTING**



**BANNER
SUPPORT
SYSTEMS**



**TEXTILE
& PVC
BANNERS**

Banner Box

Catalogue **2011/12**

www.bannerbox.co.uk



BANNER BOX

incorporating





ŠkodaAuto



Pop-up Banners

- Integral patented frame
- Lightweight and robust
- Use indoor and outdoor
- Digital or screen printed
- Set up in just 20 seconds



Square Pop-ups

Square Pop-up Banners feature:

- Generous artwork area
- Fit together for long runs
- Available in 2 sizes

All our Pop-ups can be assembled in twenty seconds!

Simply unpack these ultra lightweight, self-erecting banners from the carry case - and up they pop! Only this banner system lets you go from bag to installed in 20 seconds flat. Peg them down if you're outdoors and the job's done - bright, colourful, innovative, and extremely easy to use.

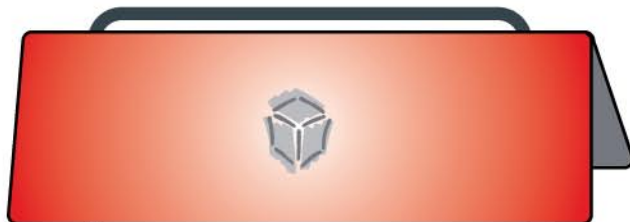

3000mm x 1000mm
Large Square



2000mm x 1000mm
Medium Square

Oval Pop-ups

Pop-up Banners feature:

- Integral frame
- Available in 4 sizes
- Simplicity itself to transport and store
- Matt finish panels - ideal for photography
- Twin faces for all round impact
- Comes complete with carry case & pegs



2000mm x 1000mm

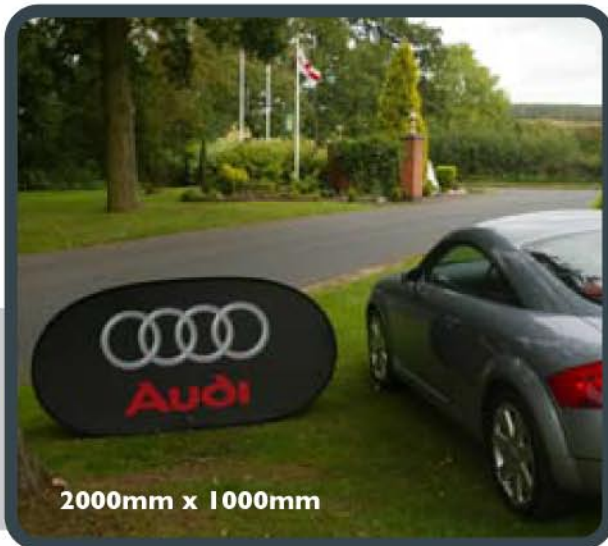

2000mm x 1000mm

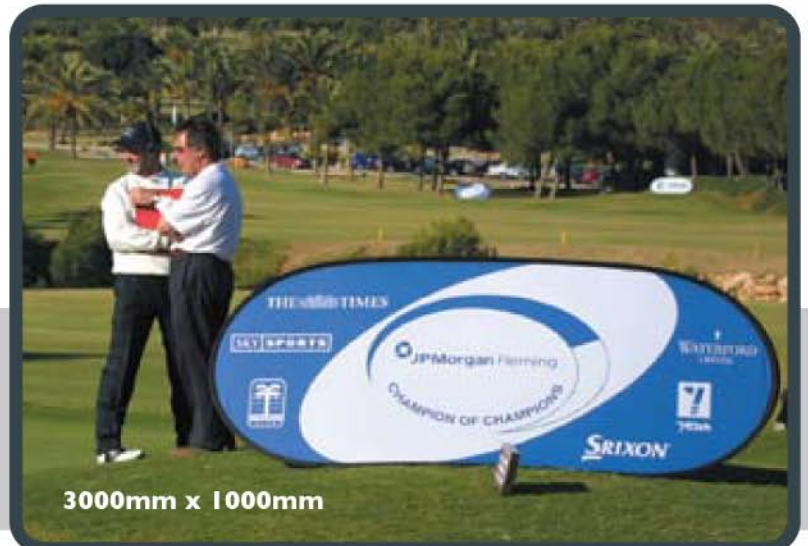

3000mm x 1000mm

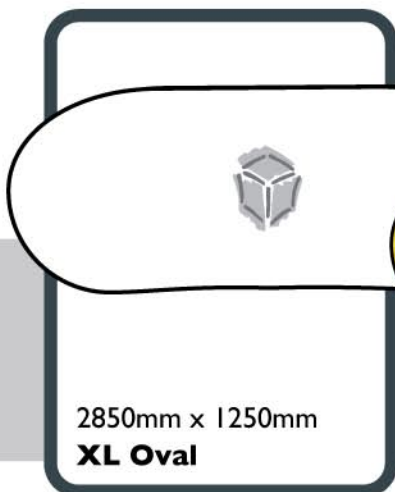

2850mm x 1250mm
XL Oval

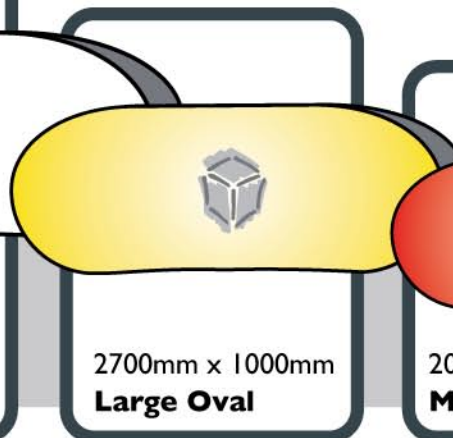

2700mm x 1000mm
Large Oval

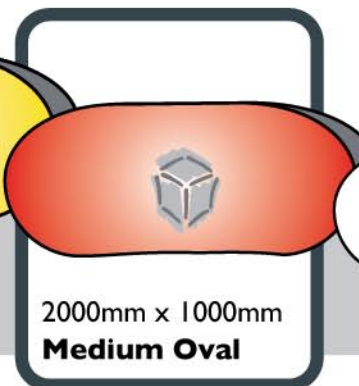

2000mm x 1000mm
Medium Oval



1200mm x 700mm
Mini Oval

Round & Tower Pop-ups

Pop-up Banners feature:

- Integral frame
- Available in 5 sizes
- Simplicity itself to transport and store
- Matt finish panels - ideal for photography
- Twin faces for all round impact
- Comes complete with carry case & pegs



2m x 1m



1400mm

700mm

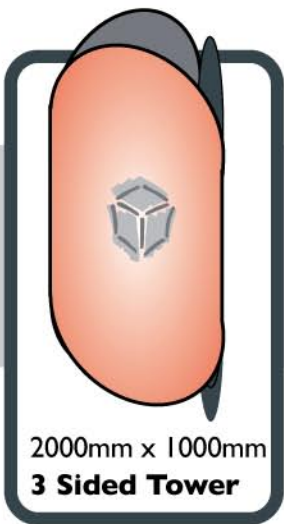

2000mm x 1000mm
3 Sided Tower

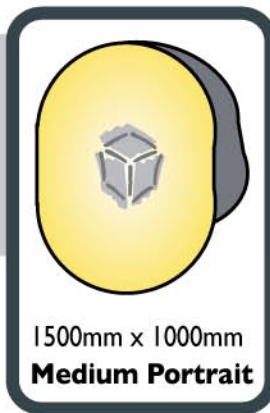

1500mm x 1000mm
Medium Portrait

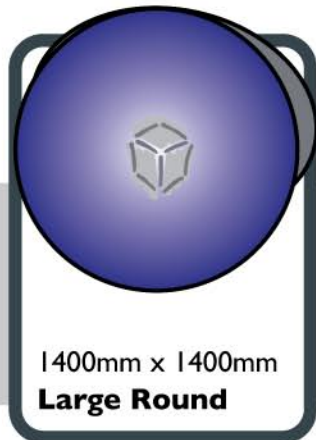

1400mm x 1400mm
Large Round

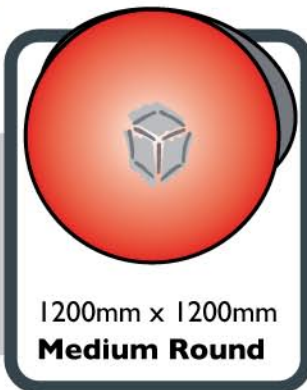

1200mm x 1200mm
Medium Round



700mm x 700mm
Mini Round



◀ From Chesterfield



The Banner Box Difference

Banner Box is a leading manufacturer and supplier of many types of banners, banner support systems, flags and flagpoles, large format graphics and bespoke promotional structures. On our customers behalf we have invested in modern manufacturing and finishing facilities and the latest printing and dye sublimation technology, in order to help you meet the challenges of busy and fast-moving markets. Whatever indoor or outdoor promotional display materials you require, we will always aim to meet your deadlines and exceed your expectations.

Contact

Adelphi Way
Ireland Industrial Estate
Staveley
Chesterfield
S43 3LS

T: 01246 472949
F: 01246 280476
sales@bannerbox.co.uk
www.bannerbox.co.uk



The paper used for this brochure contains 100% recycled fibre from post-consumer waste. Please dispose of this brochure responsibly.



BANNER BOX

